



FIBER SENSOR

BRF SERIES

INSTRUCTION MANUAL

- BRF-□ Standard B2RF-□ Extension Amp. Standard
- BRF-H□ Speed B2RF-H□ Extension Amp. Speed
- BGF-□ Mark sensing B2GF-□ Extension Amp. Mark sensing
- BIF-□ Moisture sensing B2IF-□ Extension Amp. Moisture sensing

- Confirm if the item meets your needs.
- Before the use, you should first thoroughly read this manual and operate correctly as mentioned.
- You should keep this manual at hand for proper use.

Specification

Type	Standard	High Speed	Mark Sensing	Moisture Sensing	
Normal	Cable Type	BRF(N,P)	BRF-H(N,P)	BGF(N,P)	BIF-W(N,P)
	Connector Type	BRF-C(N,P)	BRF-CH(N,P)	BGF-C(N,P)	BIF-CW(N,P)
Extension	Cable Type	B2RF(N,P)	B2RF-H(N,P)	B2GF(N,P)	B2IF-W(N,P)
	Connector Type	B2RF-C(N,P)	B2RF-CH(N,P)	B2GF-C(N,P)	B2IF-CW(N,P)
Light Source	Red LED	Red LED	Green LED	Infrared LED	
Supply Voltage	DC10 ~ 30V including 10% ripple(P-P)				
Current Consumption	normal type 25mA max.(12V) , extension amp. type 35mA max.(12V)				
Response Time	250 μs	50 μs	250 μs	1ms	
Timer Function	40ms Off delay timer				
Sensitivity Adjustment	10 rotation volume				
Indicator	Output indicator (orange LED)				
Control Output	NPN/PNP open collector DC30V 100mA max.				
Operation Mode	Light ON / Dark ON switch selectable				
Circuit Protection	Reverse polarity / output over current / short circuit protection				
Ambient Temp. / Humid.	-25~55°C *1/ 35~85%				
Ambient Illuminance	sunlight: 10,000 lx max. incandescent light: 3,000 lx max.				
Protection Category / Material	normal type: IE Standard IP66, extension amp. type:IE Standard IP50 / housing : PBT cover : PC				
Weight	cable type: about 70g / connector type: about 25g / extension amp. cable type: about 20g / extension amp. connector type: about 25g				

*1 extension 3-4pcs -25~50°C Moisture Types (BIF-W, etc) are not connectable together with other types due to slower response time.

Warnings

- Usage in the following environment must cause damages.
 - Dusty and vaporous place
 - Corrosive gas environment
 - Water and oil scattering environment
 - Intense shock and vibration
- In case of switching regulator, frame ground (FG) must be grounded.
- Warm-up period (approx. 100 ms.) must be secured.
- Should avoid parallel wiring with high-voltage wire and/or power line. Never install in same conduit.

⚠ Must not use the item for the purpose of human body protection.

Parts name

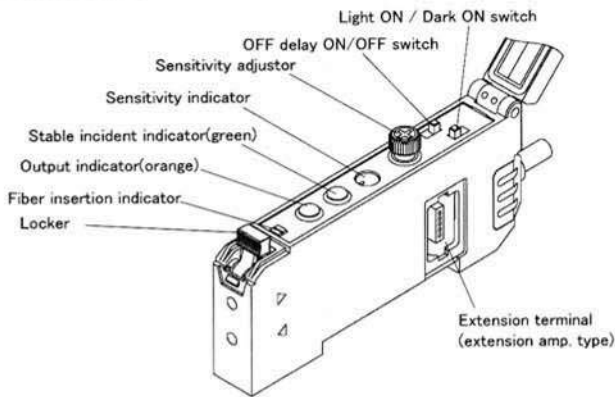

Set up amplifier unit

● Set up:

- ① Attach the front of the amplifier onto the DIN rail or bracket.
- ② Push the back of the amplifier down until it snaps on.

● Removal:

Push the amplifier forward as shown by the arrow and lift the front to release.

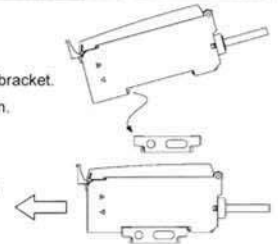

Set up fiber unit

- ① Open the protective cover
- ② Push the fiber lock lever down to unlock.
- ③ Insert the fiber cables into the amplifier until the indicator shows
- ④ Lock the cables in by closing the fiber lock lever.

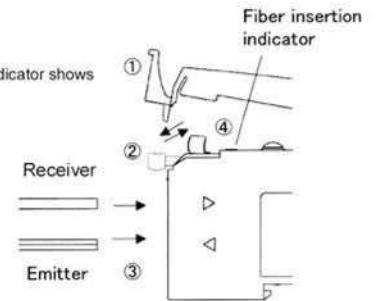

- To remove the cables, unlock the lever by pushing it down and pull the cables out.

* Coaxial type - the cable with the white stripe or the single fiber core is the emitter, the cable with the multiple strands is the receiver.

Cable In/Out (extension amp. type)

- Connecting: Push the cable until it snaps into the locked position.
- Removing: Press the lever down and pull back.

Warning! Excessive pressure on the lever will damage it or the connector.

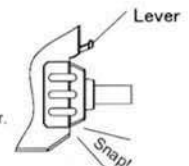

Adjusting the potentiometer

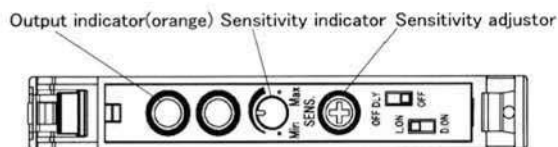

- ① Set the target at the position it is to be detected, turn the potentiometer from MIN towards MAX until the output indicator (orange) turns on. Call this position A.

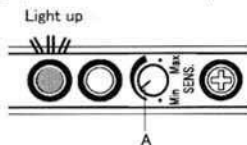

- ② Remove the target and turn the potentiometer from MAX towards MIN until the output indicator (orange) turns off. Call this position B.

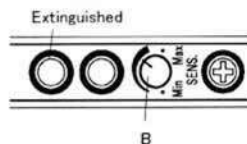

- ③ Turn the potentiometer to the point midway between points A and B (this is point C), this is the optimal sensitivity setting.

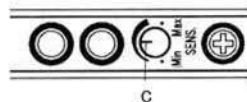

The position of points A and B may be reversed depending upon the type of fiber used and the detecting situation.

Fiber unit:

- Fine diameter adapter

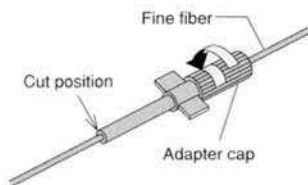

- ① Turn the fiber adapter cap fully counter-clockwise, insert the fiber cable to the desired position. Turn the fiber adapter cap back clockwise to lock.
- ② Use the fiber cutter to cut the cable to the desired length.

Caution: Repeated use of the fiber cutter will cause it to lose its edge and result in poor performance.

Amplifier extension (extension amp. type)

● Extension

- ① Attach the extension connector to the amplifier.
- ② Mount the amplifier onto the DIN rail and slide into position next to the amplifier that is to be connected to.

● Removal

Slide apart and remove from DIN rail.

! Moisture Types (BIF-W, etc.) are not compatible with other types due to a slower response time.

! When connecting more than 3 amplifiers together the ambient temperature must be in the range of -25 to +50 degrees C.

! When connecting amplifiers together use the DIN rail stop BEF-EB01-W190 to hold the amplifiers in place.

! Turn the power off when connecting amplifiers together.

! Attach the protective cover the the amplifier openings at either end of the row.

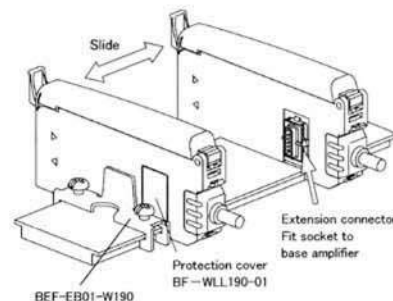

Check (extension amp. type)

● Interference protection

The interference prevention functions in groups of four amplifiers. You are requested to install the amplifiers in multiples of four when interference prevention is required. Any amplifier can be the Master or the Slave.

! Moisture Types (BIF-W, etc.) are not able to be connected with other types due to the slower response time.

! Interference prevention is not incorporated in the High Speed models.

● Ambient temp

The ambient temperature rating is limited by the number of amplifiers used and the ambient temperature. We guarantee parallel installation of up to 16 amplifiers when following the temperature rating's listed in the table to the right.

4 amplifiers as a group for interference prevention.

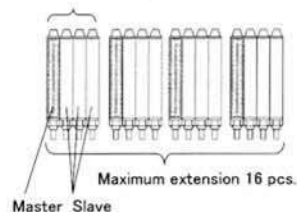

extension	ambient temp
2pcs	+55° max
3~10pcs	+50° max
11~16pcs	+45° max

※supply voltage 24V

Input/ Output circuit design

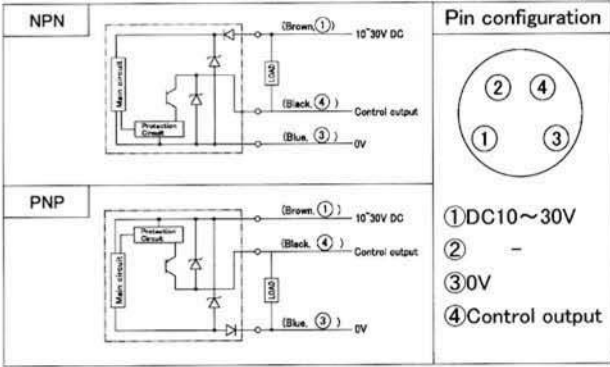

Options

- Cable
 - Base cable DOL-LL1903-02M DOL-LL1903-05M
 - Sub cable DOL-LL1901-02M DOL-LL1901-05M
- Extension connector
 - for cable type STE-WLL190-05P Attachment
 - for connector type STE-WLL190-03P
- Protective cover for the extension type amplifiers (2pcs)
- BF-WLL190-01
- DIN rail mounting fixture BEF-EB01-W190

Dimensions

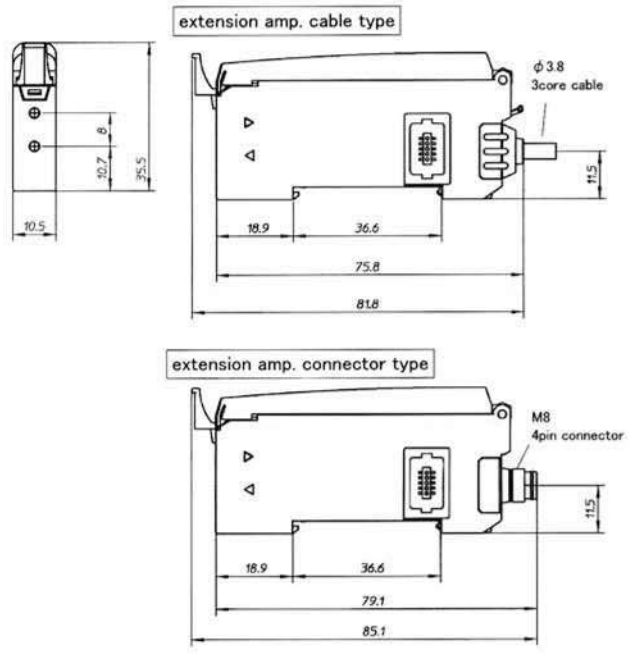
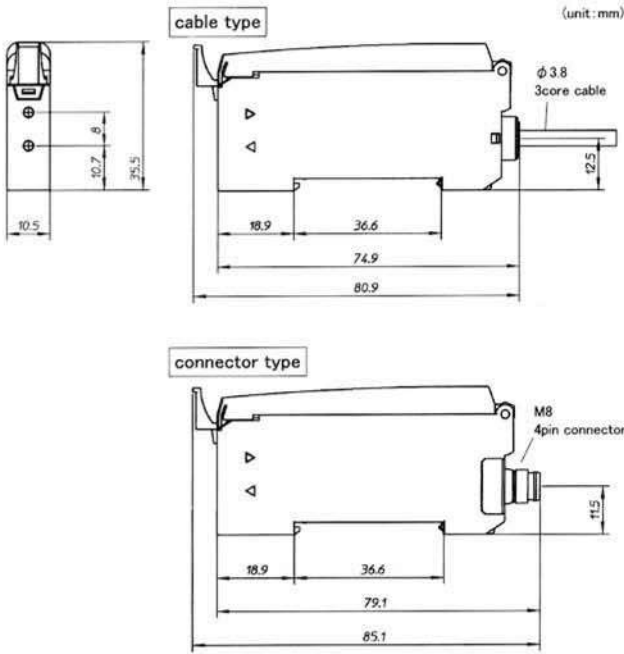

- Specifications and equipment are subject to change without any obligations on the part of manufacture.
- For more information, questions and comments regarding products, please contact us below.

Developed by :

OPTEX CO.,LTD.

Manufactured and sold by :

OPTEX F.A. OPTEX FA CO.,LTD.